

Lever Actuator Switch for Distribution Board

- For Distribution Boards, IP40
- NEMA Type 1 Handle
- IP20 Body



DC21A IEC60947-3				UL Ratings UL508I				Poles in series	No. of Strings	Weight Kg./pcs.	Part Number	Contact Configuration
600V	800V	1000V	1500V	350V	500V	600V	1000V					
16A	16A	9A	3A	16A	16A	16A	-	2	1	0.19	SI16 DB 2	
25A	20A	11A	4A	20A	20A	20A	-	2	1	0.19	SI25 DB 2	
32A	23A	13A	5A	25A	25A	25A	-	2	1	0.19	SI32 DB 2	
40A	30A	20A	10A	40A	40A	40A	16A	2	1	0.41	SI40 DB 2	
55A	45A	36A*	15A	55A	55A	55A	20A	2	1	0.41	SI55 DB 2	
29A	16A	9A	3A	29A	29A	21A	-	2	1	0.24	SI16 DB 2H	
45A	20A	11A	4A	45A	38A	23A	-	2	1	0.24	SI25 DB 2H	
50A	23A	13A	5A	58A	40A	25A	-	2	1	0.24	SI32 DB 2H	
64A	30A	20A	6A	72A	53A	42A	22A	2	1	0.52	SI40 DB 2H	
80A	45A	25A	8A	85A	66A	55A	25A	2	1	0.52	SI55 DB 2H	
16A	16A	9A	3A	16A	16A	16A	-	2	2	0.22	SI16 DB 4	
25A	20A	11A	4A	20A	20A	20A	-	2	2	0.22	SI25 DB 4	
32A	23A	13A	5A	25A	25A	25A	-	2	2	0.22	SI32 DB 4	
40A	30A	20A	6A	40A	40A	40A	16A	2	2	0.45	SI40 DB 4	
55A	45A	36A*	8A	55A	55A	55A	20A	2	2	0.45	SI55 DB 4	
16A	16A	16A	16A	16A	16A	16A	-	4	1	0.23	SI16 DB 4S	
25A	25A	25A	20A	25A	25A	25A	-	4	1	0.23	SI25 DB 4S	
32A	32A	32A	23A	32A	32A	32A	-	4	1	0.23	SI32 DB 4S	
40A	40A	40A	30A	40A	40A	40A	40A	4	1	0.49	SI40 DB 4S	
55A	55A	55A	40A	55A	55A	55A	55A	4	1	0.49	SI55 DB 4S	
16A	16A	9A	3A	16A	16A	16A	-	2	3	0.35	SI16 DB 6	
25A	20A	11A	4A	20A	20A	20A	-	2	3	0.35	SI25 DB 6	
32A	23A	13A	5A	25A	25A	25A	-	2	3	0.35	SI32 DB 6	
16A	16A	9A	3A	16A	16A	16A	-	2	4	0.40	SI16 DB 8	
25A	20A	11A	4A	20A	20A	20A	-	2	4	0.40	SI25 DB 8	
32A	23A	13A	5A	25A	25A	25A	-	2	4	0.40	SI32 DB 8	
29A	29A	29A	16A	29A	29A	29A	-	4	1	0.43	SI16 DB 4H	
45A	45A	45A*	20A	45A	45A	45A	-	4	1	0.43	SI25 DB 4H	
58A	58A*	58A*	23A	58A	58A	50A	-	4	1	0.43	SI32 DB 4H	

4T / 4B configuration also available. For ratings refer to 4S configuration. (See page 17)

* DC21B

Lever Actuator Switch - Panel Mounting

- Panel Mounting, IP66
- Escutcheon Plate 64mm²
- NEMA Type 3R Handle
- IP20 Body



DC21A IEC60947-3				UL Ratings UL508I				Poles in series	No. of Strings	Weight Kg/pcs.	Part Number	Contact Configuration
600V	800V	1000V	1500V	350V	500V	600V	1000V					
16A	16A	9A	3A	16A	16A	16A	-	2	1	0.20	SI16 PM64 2	
25A	20A	11A	4A	20A	20A	20A	-	2	1	0.20	SI25 PM64 2	
32A	23A	13A	5A	25A	25A	25A	-	2	1	0.20	SI32 PM64 2	
40A	30A	20A	6A	40A	40A	40A	16A	2	1	0.41	SI40 PM64 2	
55A	45A	36A*	8A	55A	55A	55A	20A	2	1	0.41	SI55 PM64 2	
29A	16A	9A	3A	29A	29A	21A	-	2	1	0.25	SI16 PM64 2H	
45A	20A	11A	4A	45A	38A	23A	-	2	1	0.25	SI25 PM64 2H	
50A	23A	13A	5A	58A	40A	25A	-	2	1	0.25	SI32 PM64 2H	
64A	30A	20A	6A	72A	53A	42A	22A	2	1	0.54	SI40 PM64 2H	
80A	45A	25A	8A	85A	66A	55A	25A	2	1	0.54	SI55 PM64 2H	
16A	16A	9A	3A	16A	16A	16A	-	2	2	0.23	SI16 PM64 4	
25A	20A	11A	4A	20A	20A	20A	-	2	2	0.23	SI25 PM64 4	
32A	23A	13A	5A	25A	25A	25A	-	2	2	0.23	SI32 PM64 4	
40A	30A	20A	6A	40A	40A	40A	16A	2	2	0.52	SI40 PM64 4	
55A	45A	36A*	8A	55A	55A	55A	20A	2	2	0.52	SI55 PM64 4	
16A	16A	16A	16A	16A	16A	16A	-	4	1	0.24	SI16 PM64 4S	
25A	25A	25A	20A	25A	25A	25A	-	4	1	0.24	SI25 PM64 4S	
32A	32A	32A	23A	32A	32A	32A	-	4	1	0.24	SI32 PM64 4S	
40A	40A	40A	30A	40A	40A	40A	40A	4	1	0.52	SI40 PM64 4S	
55A	55A	55A	40A	55A	55A	55A	55A	4	1	0.52	SI55 PM64 4S	
16A	16A	9A	3A	16A	16A	16A	-	2	3	0.36	SI16 PM64 6	
25A	20A	11A	4A	20A	20A	20A	-	2	3	0.36	SI25 PM64 6	
32A	23A	13A	5A	25A	25A	25A	-	2	3	0.36	SI32 PM64 6	
16A	16A	9A	3A	16A	16A	16A	-	2	4	0.41	SI16 PM64 8	
25A	20A	11A	4A	20A	20A	20A	-	2	4	0.41	SI25 PM64 8	
32A	23A	13A	5A	25A	25A	25A	-	2	4	0.41	SI32 PM64 8	
29A	29A	29A	16A	29A	29A	29A	-	4	1	0.46	SI16 PM64 4H	
45A	45A	45A*	20A	45A	45A	45A	-	4	1	0.46	SI25 PM64 4H	
58A	58A*	58A*	23A	58A	58A	50A	-	4	1	0.46	SI32 PM64 4H	

4T / 4B configuration also available. For ratings refer to 4S configuration. (See page 17)

* DC21B

Technical Data

Data according to IEC 60947-3, VDE 0660, GB14048.3

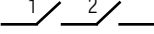
Main Contacts		Type	SI16	SI25	SI32	SI40	SI55		
Rated thermal current I_{th}		A	16	25	32	40	55		
Rated insulation voltage $U_i^{1)}$		V	1000	1000	1000	1500	1500		
Rated insulation voltage $U_i^{2)}$		V	1500	1500	1500	-	-		
Distance of contacts (per pole)		mm	8	8	8	-	-		
Rated operational current I_e									
DC21A & DC21B	1 pole 1 	300V	A	16	23	27	40	55	
		400V	A	12	14	16	30	40	
		500V	A	9	11	13	19	25	
		600V	A	6	8	10	15	20	
		700V	A	4.5	6	7.5	10	15	
		800V	A	3	4	5	8	10	
		900V	A	2.5	3	4	6	8	
DC21B	2 poles in series 2 	1000V	A	1.5	2	2.5	4	6	
		500V	A	16	25	32	40	55	
		600V	A	16	25	32	40	55	
		700V	A	16	23	27	35	55	
		800V	A	16	20	23	30	45	
		850V	A	-	-	25	-	-	
		900V	A	13	16	20	25	35	
		1000V	A	9	11	13	20	36	
		1200V	A	6	8	10	10	15	
		1500V	A	3	4	5	6	8	
		2 poles in series + 2 poles parallel 2H	500V	A	29	45	58	72	85
		600V	A	29	45	50	64	80	
		700V	A	16	23	27	35	55	
		800V	A	16	20	23	30	45	
		900V	A	13	16	20	25	35	
1000V	A	9	11	13	20	25			
1200V	A	6	8	10	10	15			
1500V	A	3	4	5	6	8			
3 poles in series + 2 poles parallel 3H	500V	A	29	45	58	-	-		
600V	A	29	45	50	-	-			
700V	A	29	38	45	-	-			
800V	A	29	38	45	-	-			
900V	A	29	38	45	-	-			
1000V	A	29	38	45	-	-			
1200V	A	12	14	16	-	-			
1500V	A	9	11	13	-	-			
4 poles in series 4S	500V	A	16	25	32	40	55		
600V	A	16	25	32	40	55			
700V	A	16	25	32	40	55			
800V	A	16	25	32	40	55			
900V	A	16	25	32	40	55			
1000V	A	16	25	32	40	55			
1200V	A	16	25	32	40	55			
1500V	A	16	20	23	30	40			
4 poles in series + 2 poles parallel 4H	500V	A	29	45	58	-	-		
600V	A	29	45	58	-	-			
700V	A	29	45	58	-	-			
800V	A	29	45	58	-	-			
900V	A	29	45	58	-	-			
1000V	A	29	45	58	-	-			
1200V	A	29	45	50	-	-			
1500V	A	16	20	23	-	-			
Rated operational current I_e									
AC21B	2, 4	U_e max. 440V	A	16	25	32	40	55	
	2H	U_e max. 440V	A	29	45	58	72	85	

1) Suitable at overvoltage category I to III, pollution degree 3 (standard-industry): $U_{imp} = 8kV$.

2) Suitable at overvoltage category I to III, pollution degree 2 (min.IP55): $U_{imp} = 8kV$.

Technical Data continued

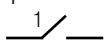
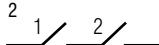
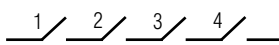

Data according to IEC 60947-3, VDE 0660, GB14048.3

Main Contacts			Type	SI16	SI25	SI32	SI40	SI55		
Rated operational current I_e			500V	A	1	1.25	1.5	x	2.5	
DC22B L/R = 2.5ms	1 pole 1 	600V	A	0.5	0.75	1	x	2		
		800V	A	0.3	0.4	0.5	x	1.5		
		1000V	A	0.15	0.2	0.25	x	1		
		1200V	A	-	-	-	x	x		
		1500V	A	-	-	-	x	x		
		2 poles in series			500V	A	7	8	9	x
	2 	600V	A	5.5	6	6.5	x	x		
		800V	A	2	2.5	3	x	x		
		1000V	A	1	1.5	2	x	x		
		1200V	A	-	-	-	x	x		
		1500V	A	-	-	-	x	x		
	4 poles in series			500V	A	16	25	32	x	x
	4S 	600V	A	16	25	27.5	x	x		
800V		A	11.5	12	12.5	x	x			
1000V		A	8	9	10	x	x			
1200V		A	-	-	-	x	x			
1500V		A	-	-	-	x	x			
Rated conditional short-circuit current				kA _{eff}	5	5	5	10	10	
Max. fuse size			gL (gG)	A	40	63	80	125	160	
Mechanical Life				x10 ⁵	10	10	10	10	10	
Rated short-time withstand current (1s)	I_{cw}	2, 4, 6, 8	A	800	900	1000	A2, A4: 1200	A2, A4: 1400		
		2H, 3H, 4H	A	1300	1500	1700	A2+2: 2000	A2+2: 2400		
Short circuit making capacity	I_{cw}	2, 4, 6, 8	A	800	900	1000	A2, A4: 1200	A2, A4: 1400		
		2H, 3H, 4H	A	1300	1500	1700	A2+2: 2000	A2+2: 2400		
Maximum cable cross sections (including jumper LSV-B1)										
solid or stranded				mm ²	4 - 16	4 - 16	4 - 16	2.5 - 25	2.5 - 25	
flexible				mm ²	4 - 10	4 - 10	4 - 10	4 - 16	4 - 16	
flexible (+ multicore cable end)				mm ²	4 - 10	4 - 10	4 - 10	2.5 - 16	2.5 - 16	
Size of terminal screw					M4 Pz2	M4 Pz2	M4 Pz2	M5 Pz2	M5 Pz2	
Tightening torque				Nm	1.2 - 1.8	1.2 - 1.8	1.2 - 1.8	2.5 - 2.8	2.5 - 2.8	
2 cables per clamp without jumper LSV-B1 / LSV-B2										
solid or stranded				mm ²	16+(1.5-2.5)/10+(1.5-6)/6+(1.5-10)/4+(1.5-10)			16+(1.5-2.5)/10+(1.5-10)/6+(1.5-10)/4+(1.5-10)		
flexible & flexible + multicore cable end				mm ²	16+(1.5-2.5)/10+(1.5-4)/6+(1.5-6)			16+(1.5-6)/10+(1.5-10)/6+(1.5-16)/4+(1.5-16)		
stranded				AWG	8+(16-12)/10+(16-10)/12+(16-8)/14+(16-8)			3+(18-10)/4+(18-10)/6+(18-8)/8+(18-8)		
solid				AWG	10+(16-12)/12+(16-10)/14+(16-10)			10+(16-10)/12+(16-10)/14+(16-10)/12+(16-10)/14+(16-10)		
Maximum ambient temperature				°C						
Operation	All types except PEL64R			°C				-40 to +65		
	PEL64R type			°C				-40 to +45		
Storage				°C				-50 to +70		
Power loss per switch at $I_{e,max}$ DC21B				W						
2				W	0.8	2	3	4	6	
4				W	1.6	4	6	8	12	
6				W	2.4	6	9	12	18	
8				W	3.2	8	12	16	24	
2H				W	0.4	1	1.5	2	3	
3H				W	0.6	1.5	2.25	3	4.5	
4H				W	0.8	2	3	4	6	





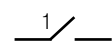
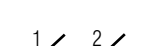
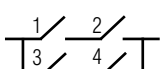
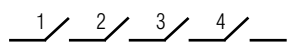
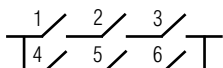
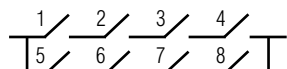

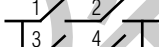
x - In Test

Technical Data continued

Data according to UL508i  File E362605 and UL508  File E146487, Category no.: NRNT2, NRNT8

Main Contacts	Type	S116	S125	S132	S140	S155	
Ampere-Rating "General Use" 1 pole 	DC						
	350V A	4	5	6	7.1	10	
	500V A	4	5	6	5.7	7	
	600V A	4	5	6	5	5.8	
	700V A	-	-	-	3.9	5	
	800V A	-	-	-	3.2	4.4	
	900V A	-	-	-	2.5	3.5	
	1000V A	-	-	-	1.5	2	
	2 poles in series 2 	350V A	16	20	25	40	55
		500V A	16	20	25	40	55
600V A		16	20	25	40	55	
700V A		-	-	-	32	46	
800V A		-	-	-	26	37	
900V A		-	-	-	20	28	
1000V A		-	-	-	16	20	
2 poles in series + 2 poles parallel 2H 		350V A	29	45	58	72	85
		400V A				67	79
		500V A	29	38	40	53	66
	600V A	21	23	25	42	55	
	700V A	-	-	-	35	47	
	800V A	-	-	-	30	40	
	900V A	-	-	-	26	32	
	1000V A	-	-	-	22	25	
	4 poles in series 4S 	350V A	16	25	32	40	55
		500V A	16	25	32	40	55
600V A		16	25	32	40	55	
700V A		-	-	-	40	55	
800V A		-	-	-	40	55	
900V A		-	-	-	40	55	
1000V A		-	-	-	40	55	
3 poles in series + 2 poles parallel 3H 		350V A	29	45	58	-	-
	500V A	29	38	50	-	-	
	600V A	21	38	45	-	-	
4 poles in series + 2 poles parallel 4H 	350V A	29	45	58	-	-	
	500V A	29	45	58	-	-	
	600V A	29	45	50	-	-	
AC Rating "General Use" 2 poles in series 	600V A	16	25	32	x	x	
	277V A	-	-	50	x	x	
2 poles in series + 2 poles parallel 	3x480V A	-	-	32	-	-	
Fuse size (RK5) Industrial Control Switch 5kA / 600V 5kA / 1000V	A A	40 -	60 -	80 -	- 90	- 125	
Maximum cable cross sections (including jumper SIV-B1/B2)	solid or stranded	AWG	12 - 10	12 - 10	12 - 10	16 - 10	16 - 10
	flexible	AWG	12 - 6	12 - 6	12 - 6	14 - 4	14 - 4
	flexible (+ multicore cable end)	AWG	12 - 6	12 - 6	12 - 6		
	Size of terminal screw		M4 Pz2	M4 Pz2	M4 Pz2	M5 Pz2	M5 Pz2
Tightening torque	lb.inch	9 - 16	9 - 16	9 - 16	22 - 25	22 - 25	

x - In Test

Approvals	Country	RoHS	USA, UL508i	US, Canada, UL508	Europe CE	TUV Rheinland	GOST Russia	IEC CB Europe
								
	S116	✓	✓	✓	✓	✓	✓	✓
	S125	✓	✓	✓	✓	✓	✓	✓
	S132	✓	✓	✓	✓	✓	✓	✓
	S140	✓	✓	✓	✓	Pending	Pending	Pending
	S155	✓	✓	✓	✓	Pending	Pending	Pending

Dimensions

SI16PM / SI25PM / SI32PM
2

2H, 4

SI + X "Y"
Extended Switch Shaft

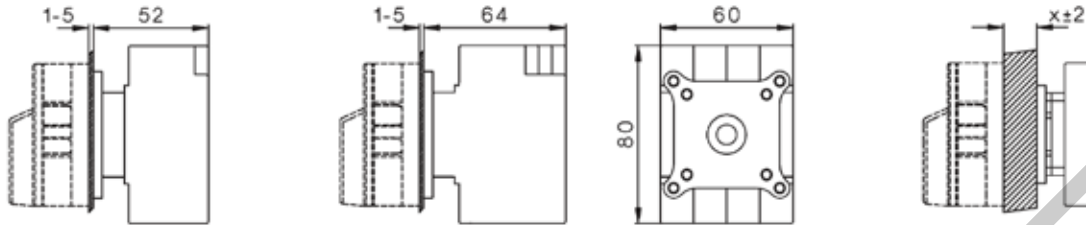

SI16PM / SI25PM / SI32PM
6, 8, 4H

SI40PM / SI55PM
2, 2H, 4

Mounting Hole

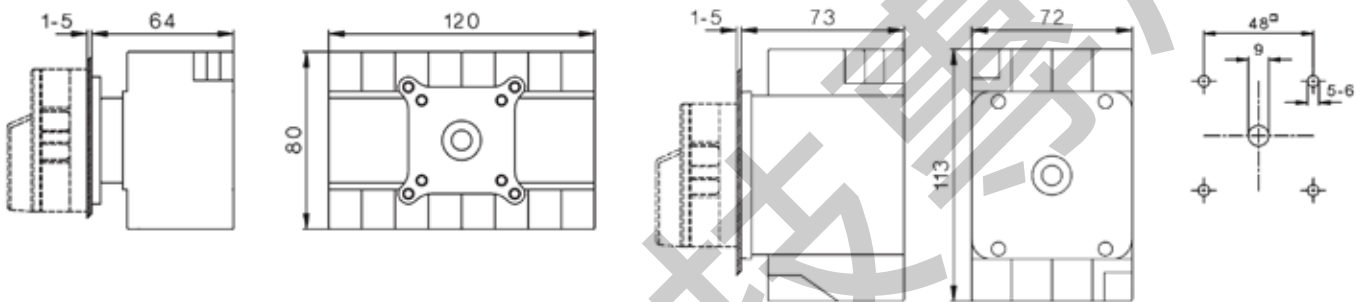

Escutcheon Plate 64
Lever

Lockable Lever

Lockable Rotary

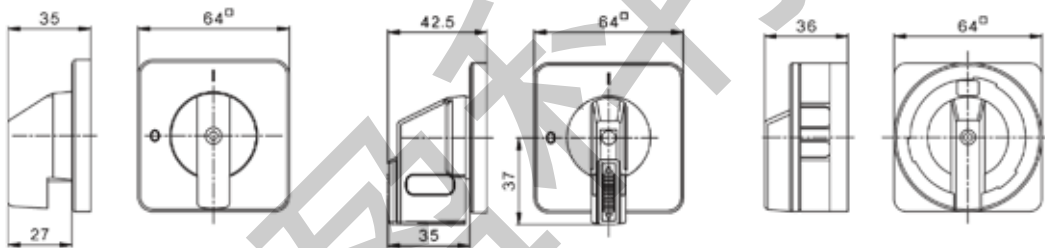

SI16SHM(L) / SI25SHM(L) / SI32SHM(L)
2

2H, 4

Mounting Hole

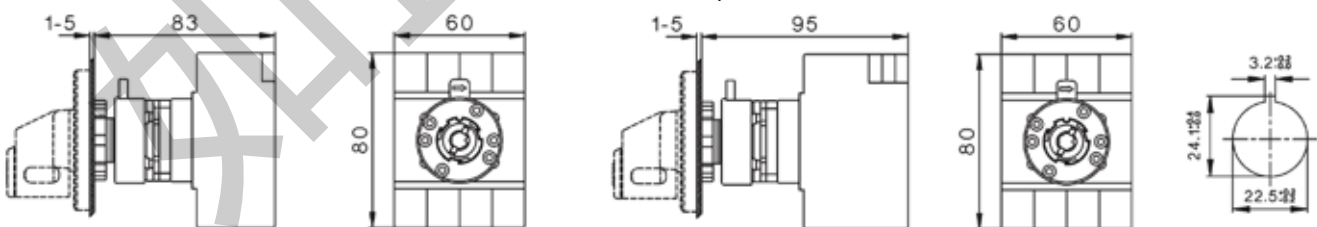

Escutcheon Plate 48
Lever Handle

Lockable Lever

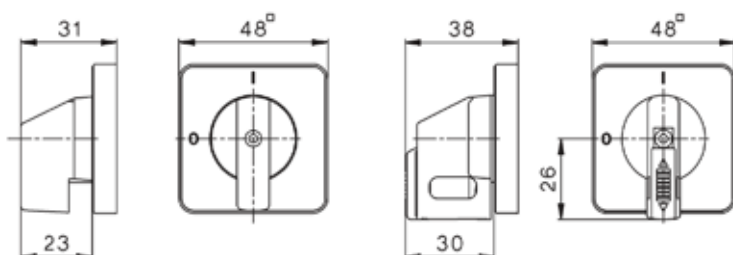

Dimensions continued

SI16DB(L) / SI25DB(L) / SI32DB(L)
2

2H, 4

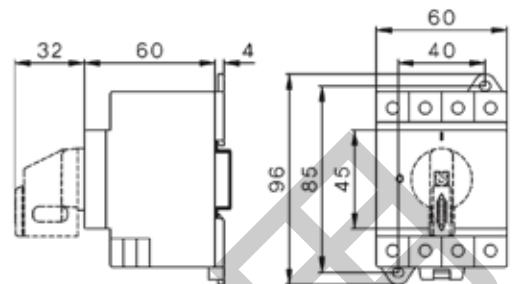
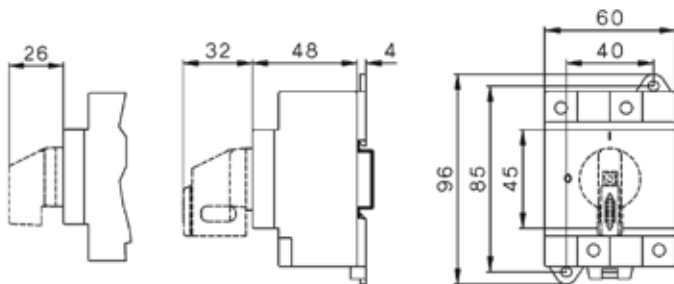

SI40DB(L) / SI55DB(L)
2, 2H, 4

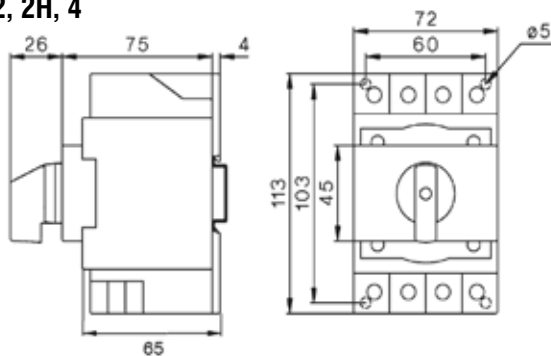

SI16DB(L) / SI25DB(L) / SI32DB(L)
6, 8, 4H

SI.. DBL with low height handle
2-LH

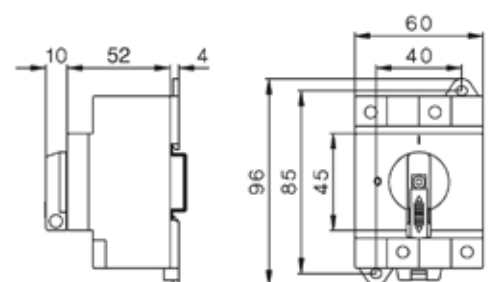
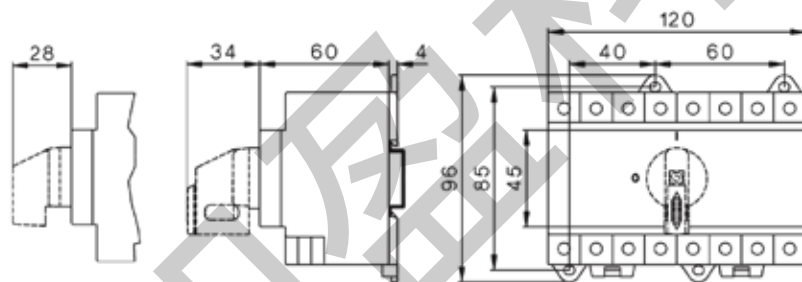

SI16DBL / SI25DBL / SI32DBL with low height handle
2H-LH, 4-LH

4H-LH, 6-LH, 8-LH

